



**BWI Global Packaging & Shipping Standards
for Production Parts**

Specification No: 22335479

Revision: 001
May 2018

FOREWORD

Prepared by the BWI Corporate Packaging Activity in cooperation with Logistics, Packaging Engineering, Industrial Engineering, Production Control and Global Supply Management, this manual provides standards for packaging and shipping products into BWI facilities.

Table of contents

1 INTRODUCTION.....	5
2 PACKAGING DEVELOPMENT & APPROVAL	6
BWI Responsibilities	6
Supplier Responsibilities	6
3 GENERAL REQUIREMENTS.....	7
PRICING	7
DESIGN	7
PACKAGING AGREEMENT SUBMISSION.....	9
CHOOSING THE RIGHT CONTAINER	9
ERGONOMIC REQUIREMENTS.....	11
TESTING AND VALIDATION.....	11
HAZARDOUS MATERIALS.....	12
4 EXPENDABLE PACKAGING SYSTEMS	13
PALLET SIZE AND CONSTRUCTION	13
CONTAINER SIZE AND CONSTRUCTION.....	15
CONTAINER SIZE AND CONSTRUCTION continued	17
CONTAINER CLOSURE.....	18
CONTAINER SECUREMENT	18
UNACCEPTABLE DESIGN CHARACTERISTICS	19
EXPORT / IMPORT REQUIREMENTS	19
5 RETURNABLE PACKAGING SYSTEMS.....	20
MAINTENANCE, REPAIR AND CLEANING.....	20

RETURNABLE PACKAGING OWNERSHIP..... 21

6 INTERNAL DUNNAGE 22

7 SHIPPING LABELS 22

8 MIXED LOADS 23

9 SHIPPING PARTIAL LAYERS 24

10 SHIPPING STANDARDS 25

11 PACKAGING EXAMPLES 26

12 RECYCLING INFORMATION 27

13 FORMS AND SUPPLEMENT REQUIREMENTS 29

Attachment A1 – Standard Container Menu: North American Standards 30

Attachment A2 – Standard Container Menu: International Standards 31

Attachment A3 – Standard Container Menu: North American Standard Returnables 32

Attachment A4 – Standard Pallet Menu: North American & International Standards 33

Attachment A5 – CHEP packaging types for EU 34

Attachment B – BWI Supplier Packaging Information Form (SPI) – Example Only 35

Attachment C – Supplier Packaging Selection Checklist 36

Attachment D – Supplier Ship Compliance Checklist 37

Attachment E – Packaging Receiving Checklist 38

GLOSSARY OF TERMS 39

1 INTRODUCTION

As an integral part of the BWI Customer Specific Requirements detailing how to do business with BWI, the BWI Global Packaging & Shipping Manual specifies the packaging /shipping standards for material being shipped to BWI. The requirements in this manual must be applied to all current and future parts shipped to BWI; they take precedence over any previous guidelines or requirements.

The intent of these standards is to ensure safe movement, part quality, freight cube optimization, lean implementation and control of total costs. The responsibility for ensuring quality of material shipped remains with the supplier throughout the material movement process. Compliance to all local regulations is required.

The following are basic requirements that a supplier must adhere to in both the development of a packaging plan and the application of the shipping requirements. Upgraded standards may be required for your specific applications. Additionally, these requirements may be modified by supplemental requirements of the receiving BWI facility. The use of these standards or approvals of the BWI Supplier Packaging Information (SPI) form does not relieve the supplier of responsibility for part quality. These requirements should be applied to all production parts prior to quote submission. BWI's Product Line Supplier Packaging Leader must approve all exceptions.

It is expected that each supplier will develop their plan to comply; all packaging changes must be managed through the BWI Change Management Process. Further, it is expected each supplier will assure all affected employees are knowledgeable and capable of compliance. It is the supplier's responsibility to ensure part quality from their plant to the point of use within BWI. If part quality is compromised, the supplier may be held liable for repacking, inspection and incremental freight costs.

Goals:

1. All parts received with superior part quality.
2. Parts presented with operator ergonomics and work cell efficiency considered.
3. Achieve maximum pack density while minimizing costs.
4. Provide for responsible final disposition of obsolete packaging materials by maximizing the use of recyclable materials to minimize disposal.
5. All parts received are to follow the size requirements as specified in the BWI Standard Container Menu (See pages 34-36)
6. Facilitate the maximum utilization of the cubic shipping footprint.

2 PACKAGING DEVELOPMENT & APPROVAL

BWI Responsibilities

- Define the preferred packaging system (expendable/returnable).
- Approve the packaging plan utilizing the SPI process.
- Assist the supplier with the packaging plan as required.
- Determine system size, quantity, and allocation of returnable containers. Monitor and assure compliance to BWI requirements.

Supplier Responsibilities

- Review this document to ensure all requirements are clearly understood and met.
- Discuss with your BWI contact any specific requirements of the receiving BWI manufacturing facility.
- Ensure that pack validation can be completed within program start up dates.
- Returnable packaging designed, owned, and provided by the supplier must be approved by the BWI's Product Line Supplier Packaging Leader before shipments commence. The supplier's name and the container identification must be clearly visible on each returnable container.
- Submit a completed SPI form to BWI Global Supply Management with all part quote submissions
- Resubmit SPI form with all proposed packaging changes (follow SCR process).
- When requested, provide for approval sample production intent packaging with parts.
- Design a back up expendable system when a returnable system is used (of same size or smaller than returnable footprint, and equal to returnable standard pack quantity) which may be required for premium shipments, production run ahead programs, returnable container outages, etc. Plan and maintain sufficient supply of suitable expendable packaging. Alternate pricing for expendable packaging costs must be prearranged with BWI Global Supply Management.
- Suppliers are responsible for designing their own expendable packaging. This includes the expendable packaging for the primary container, expendable dunnage used within expendable and returnable containers, and expendable back-up packaging for returnable container systems.
- Suppliers must monitor governmental & industry regulations to ensure their packaging conforms to all applicable requirements.
- All production intent parts must be shipped in production intent packaging; including PTR's.

3 GENERAL REQUIREMENTS

PRICING

Packaging costs must be included in all part quotations and clearly defined in the piece price.

- Supplier Packaging Information form must be submitted to BWI Global Supply Management each time when the packaging is changed.
- All packaging pricing must be negotiated with BWI Global Supply Management.
- No price increases will be granted to correct defective and/or non-conforming packaging.
- Pricing of returnable systems must be cost justified considering system size requirements, freight, housekeeping and lean material handling/processing costs.
- Pricing should not include returnable buffers required to support any internal manufacturing process. BWI will not pay for additional containers to support supplier buffers.
- Note at time of quote, any plans to reuse or reconstruct expendable system items (pallets, cartons, etc.).
- All supplier accounts will be credited an agreed period of hire days for example, 5 x Daily Hire Fees for FLC's and 7 x Daily Hire Fees for KLT's per item once CHEP products are transferred onto the BWI plant account; providing the booking is made within 48 hours of physical shipment.

DESIGN

Packaging Systems:

- Returnable packaging rented by BWI is considered mainstream.
- Maximum load heights (containers plus pallet) is defined by packaging supplied for each type of returnable boxes. For expendable packaging maximum load heights must not exceed:
 - 1000mm (40") for mega trailer in EU,
 - 1100mm (43") in China,
 - 1320mm (52") in NA, Mexico
- The stacked load must have the strength to stack three high (when full) in storage or to a height of 10.5 feet (3m), whichever is greater. All container designs must be stackable.
- The use of DO NOT STACK label, which is prohibited, will not exempt the supplier from over, short or damaged product claims and will be grounds for a Problem Report.
- BWI's modular packaging system will facilitate the maximum utilization of the cubic shipping footprint, in-plant storage and point-of-use presentation. This system is based on foot print sizes for each regions:
 - 1000 x 600mm or 1200 x 1000mm for returnable containers in EU
 - 1200 x 1000mm, 1200 x 800mm or 800 x 600mm for expendable containers in EU
 - 1200 x 1000mm for expendables containers in China
 - 48"x45" or 32"x30" (1219x1143mm or 813x762 mm) for expendable containers in USA , Mexico

It has individual container sizes and is designed for safe manual handling, limiting individual loaded container weight is 20kg for EU, 15kg for China and 18kg for NA, Mexico.

- Reference container menus are provided in attachments of this manual.

- Package design and standard pack quantity (pieces per container) shall not vary except when approved by BWI.
- Suppliers are responsible for designing their own expendable packaging. This includes the expendable packaging for the primary container, expendable dunnage used within expendable and returnable containers, and expendable back-up packaging for returnable container systems. Using of emergency expendable containers required a special consideration with BWI.

- Suppliers may receive assistance from the packaging suppliers and/or from BWI. This does not relieve them of their responsibility to provide a quality part.
- When a returnable container system is required by BWI, suppliers are responsible to provide a design of dunnage and other expendable elements of packaging (if needed) that meets all BWI requirements, while ensuring part integrity during shipment.
- If there are specialized design requirements, BWI may choose to assume responsibility for the packaging design.

PACKAGING AGREEMENT SUBMISSION

BWI Supplier Packaging Information (SPI) form represents an agreement between BWI and the Supplier regarding the packaging plan for products received by BWI manufacturing facilities.

- For all quotations, suppliers must submit a SPI form for each part number.
- Changes to part number, quantities, packaging materials or dimensions require a re-submittal of the SPI form (follow SCR process).
- All exceptions or deviations to BWI's standard packaging menus must be approved by BWI's Product Line Supplier Packaging Leader. Approvals of the BWI Supplier Part Information form in no way relieves the supplier of responsibility for part quality.
- An example BWI SPI form is found on page 35.

CHOOSING THE RIGHT CONTAINER

If a specific container requirement has not been indicated in the request for quote, use the Decision Process for Container Rightsizing to select the container. This rightsizing model along with the Standard Container Menus (See Attachments A1 through A3) ensures the best rightsized container is chosen to optimize the entire material flow process from supplier through user. All Containers shipped to BWI manufacturing facilities must be chosen from the BWI Standard Container Menus. These menus represent the required container sizes, both for expendable and returnable cartons/containers, approved by BWI. However, when product dimensions dictate, an alternate container size will be permitted. Exceptions to the Standard Container Menu must be pre-approved.

Suppliers must document selected container plans by completing the SPI form. It is recommended that the supplier in SPI put a picture and/or drawing of the planned packaging.

Decision Process for Container Rightsizing

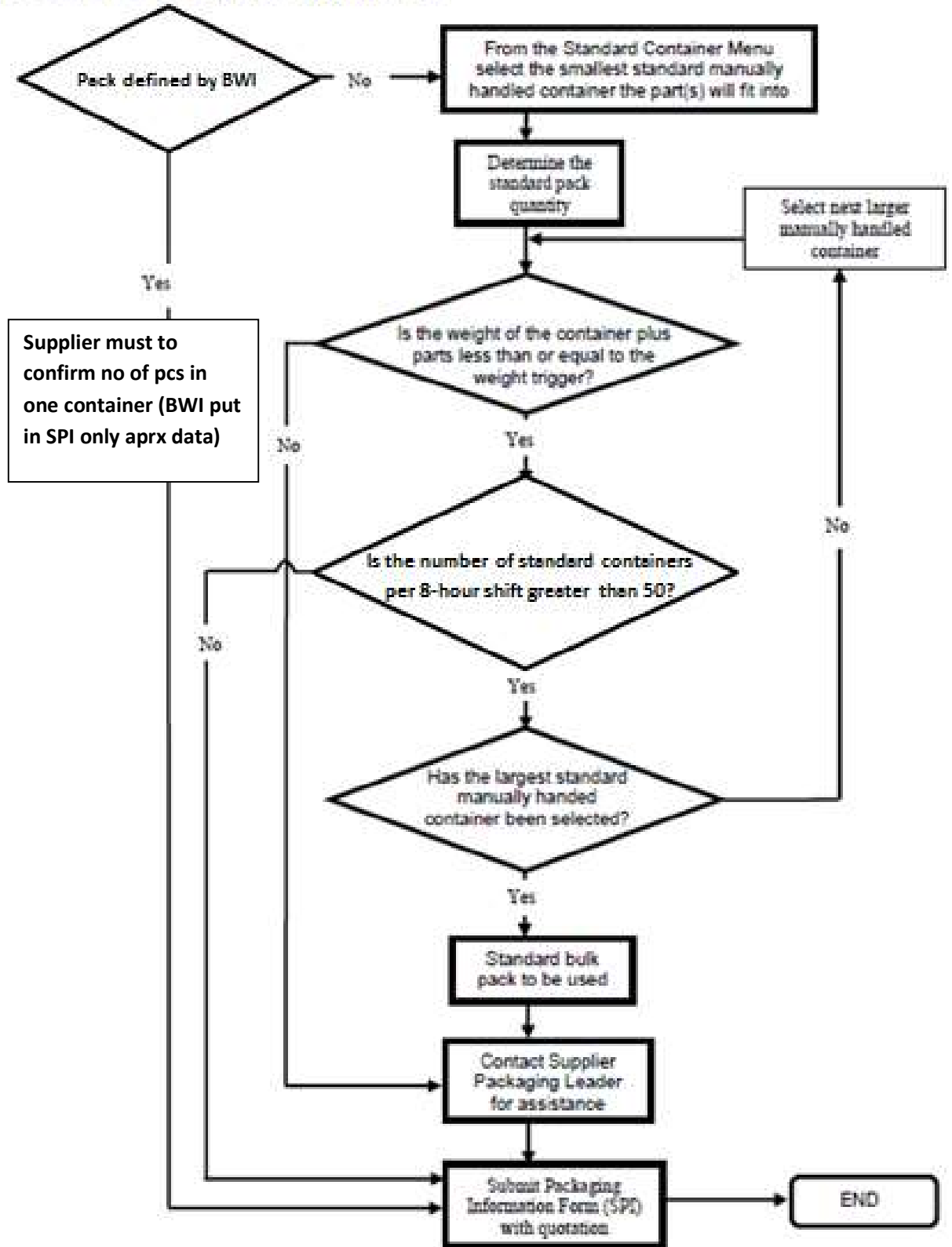

ERGONOMIC REQUIREMENTS

Weight: The maximum acceptable weight of:

- single returnable or expendable box - 20kg (50lbs) in EU,
- single returnable or expendable box - 15kg (50lbs) in EU, China
- single returnable or expendable box – 18kg (40lbs) in NA, Mexico
- bulk returnable or expendable container - 450kg (990lbs) in EU, China
- bulk returnable or expendable container - 907kg (2000lbs) in NA, Mexico

TESTING AND VALIDATION

Packaging testing is the most efficient means of ensuring the integrity and safety of contents and performance of the pack.

Supplier Responsibilities

- Ensure the part integrity during transportation and subsequent handling and storage through point of use. The supplier should test the pack design under simulated and/or real-life conditions.
- The approval by BWI of the packaging system does not relieve the suppliers of their responsibility for part integrity.
- Provide BWI with validation results and testing documentation as required.

Testing and Validation References

- ASTM (American Society for Testing and Materials)
- ISTA (International Safe Transit Association)
- COBRO (Polski Instytut Badawczy Opakowań)

Testing Laboratory Available

- Independent certified packaging test labs are available to suppliers in most geographical regions; suppliers are encouraged to select a lab that is both reputable and cost effective.
- Validation Testing: Determine if package is adequate, but not excessive.
- Pre-Shipment Testing in Laboratory: Recreate distribution hazards in a controlled environment.
- Equipment includes – Environmental Chamber, Hydraulic Vibration Table, Transportation Simulator and Incline Impact Tester, Compression Tester, Drop Test Machine.
- Certifications – ISTA, COBRO, ISO/TS 16949-2004, ISO 14001, IATF 16949: 2016
- The testing of the packaging system does not relieve the suppliers of their responsibility for part integrity.

HAZARDOUS MATERIALS

- The supplier is responsible for assuring shipment of hazardous materials are in compliance with all government regulations or any other relevant international, federal, state, provincial or local requirement.
- The supplier is responsible for informing BWI of any packaging that contains materials that may render the packaging “hazardous” as defined by the laws of the country or countries where the packaging is to be used. This information should be in the form of a notification to the supplier’s purchasing contact that includes the BWI Part Number and the hazardous constituent of concern that is incorporated in the packaging. Approval for the transfer of ownership to the using plant of hazardous packaging will require the approval of the plant environmental engineering personnel based on the availability of suitable, economical disposal.
- The shipping and receiving location’s Hazardous Material Committee must approve any additives on the parts or within the package for temporary corrosion inhibition prior to usage.
- Any corrosion inhibiting measure must be compatible with mating assemblies if the additive is to remain on the part.
- The supplier is required to provide “Material Safety Data Sheets” to the transporter of the material as well as the shipping and receiving location’s Hazardous Material Committee.

4 EXPENDABLE PACKAGING SYSTEMS

PALLET SIZE AND CONSTRUCTION

Size: BWI standard footprints are governed by the size and cube of transporting conveyance. For BWI Standard Pallet Menu see Attachment A4. Non standard pallets require approval.

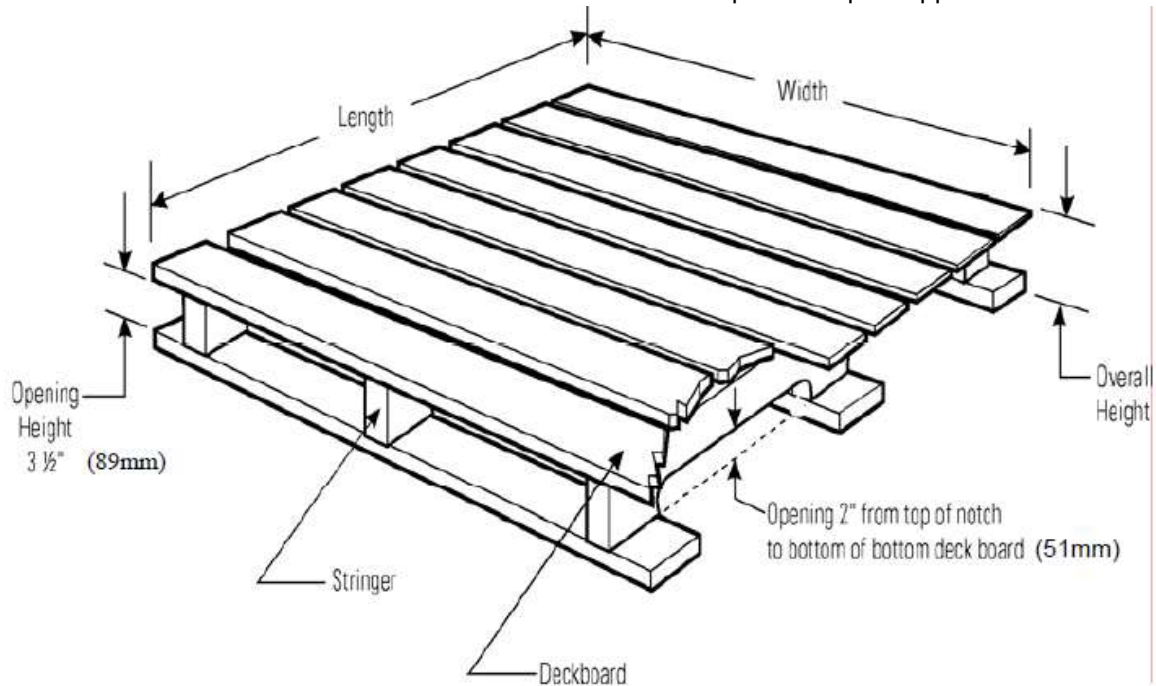

North American Standards: A 48" (1219 mm) x 45" (1143 mm) x 5" (127 mm) pallet has 48" (1219 mm) stringers, 45" (1143 mm) deck boards and the top of the deck is 5" (127 mm) above the floor. For the four-way entry pallet, the primary (easy entry) opening is across the 45" (1143 mm) width.

Non-reversible four-way entry stringer wood pallets, with 3.5" (89 mm) minimum primary opening height are required. Two-way entry may be used on 32" (812 mm) x 30" (762 mm) pallets.

International Standards: An 800 mm (31.5 in) x 1200 mm (47.2 in) x 144 mm (5.7 in) pallet has 800 mm (31.5 in) stringers, 1200 mm (47.2 in) deck boards and the top of the deck is 144 mm (5.7 in) above the floor. For the four-way entry pallet, the primary (easy entry) opening is across the 1200 mm (47.2 in) width.

Non-reversible four-way entry stringer construction wood pallets, with 89 mm (3.5 in) minimum primary opening height are required. Two-way entry may be used on 800 mm (31.5 in) x 600 mm (23.6 in) pallets.

Construction: The pallet must have the minimum strength to withstand the static and dynamic forces foreseen for the distribution environment. Pallet design criteria must be incorporated to prevent pallet deformations, damages and structural failures which detrimentally affect the functionality of the unit load. Refer to ASTM D1185 designation – Standard Test Methods for Pallets and Related Structures Employed in Materials Handling and Shipping – for testing details and pallet acceptance criteria. Additional requirements that will apply are as follows:

- Wood Pallets

- Nailed construction is required. Minimum 2 ¼" (57mm) long, four-flute helical hardened nails are recommended.
- Deck boards should be spaced close enough to provide adequate support to the product and prevent the product from falling through.
- The pallet must have the strength to stack three high (when full) in storage or to a height of 10.5 feet (3.2m), whichever is greater.
- Structural members of the pallet should be compatible with the carton by supporting the edge and corners.
- All pallets dedicated for overseas shipment must comply ISPM#15 regarding non-manufactured wood products (NMWP) regardless of country origin or destination. These requirements provide guidance on the treatment and marking of coniferous and non-coniferous wooden packaging products.
- Identification of manufacturer and / or pallet name printed on a visible pallet stringer is required.
- Pallets may be new, reconditioned or reconstructed. However, if reconstructed must be retreated and show markings that indicate conformance to ISPM #15.
- Nail heads and points are to be flush but may not exceed 1/8"(3mm) exposure from surface.
- No missing or broken deck boards top or bottom.
- No tapered breaks greater than 1" (25mm) or longer than 10" (254mm) in length.
- All stringers must be solid, not broken or have cracks visible from 3 sides or longer than 1" (25mm); weathering cracks allowable if meet above.
- No double stringers, patched boards or metal plates.
- No partial footing where stringer is ¼" (6mm) missing or deck nail shanks are exposed.
- No exposed splinters greater than 3" (76mm).
- Pallets must be clean and odor free. Aging discoloration acceptable.

- Corrugated pallets:
 - Are acceptable for use when the gross pallet weight is less than 500 pounds (226 kg). BWI's Product Line Supplier Packaging Leader must approve the type and style.
 1. A solid corrugated deck is required.
 2. If paper fiber cores are used for load-bearing members, use no more than four with a maximum thickness of $\frac{1}{4}$ " (6mm).
 3. Recyclable pallet (100% corrugated) is required.
- For pallets used in export applications, refer to the Export / Import Requirements on page 21 of this manual.

CONTAINER SIZE AND CONSTRUCTION

- The expendable container system has been designed to be modular. All material must be shipped in box sizes shown in the BWI Standard Container Menu. This allows for effective layering and utilization of the standard pallet dimensions. Any deviation to using the BWI Standard Container Menu requires prior authorization by BWI's Divisional Supplier Packaging Leader and SPI approval prior to shipment of the material. The following are expected when creating a load of material:
 - Containers must be palletized to ensure part protection and to permit handling with industrial trucks when sufficient quantities are to be shipped.
 - Brick stacking is prohibited due to loss in compression strength.

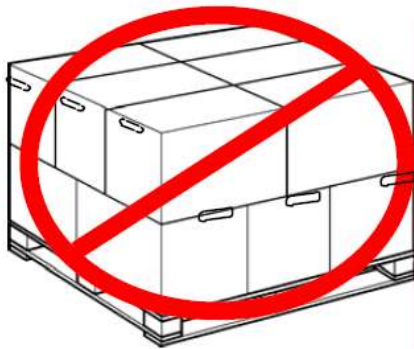

Brick stacking is prohibited.

o Flute direction must be vertical (corrugated pattern in wall of carton must have visible spaces in the vertical direction) to optimize compression strength of the carton.

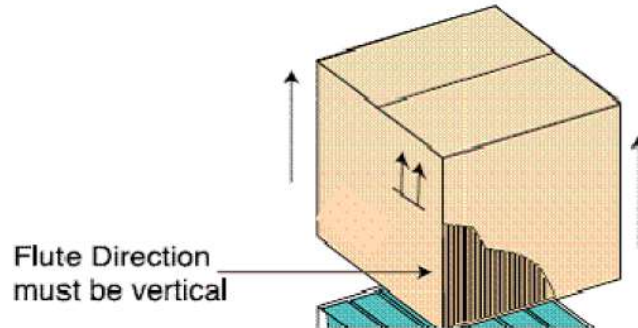

o Containers must be aligned and fully utilize the length and width of the pallet due to compression strength loss.

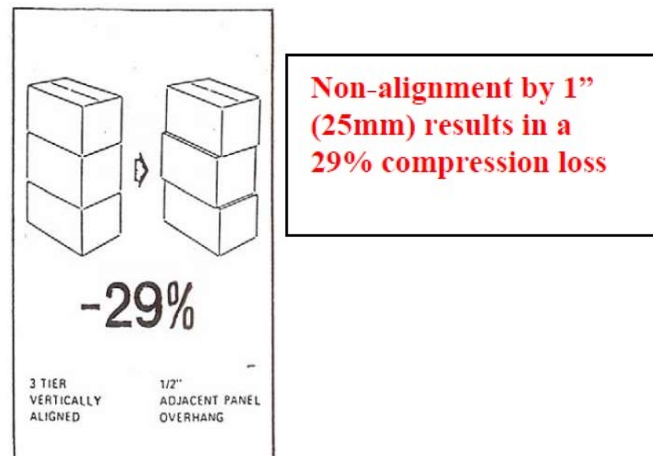

o To ensure load integrity, containers must not overhang the pallet.

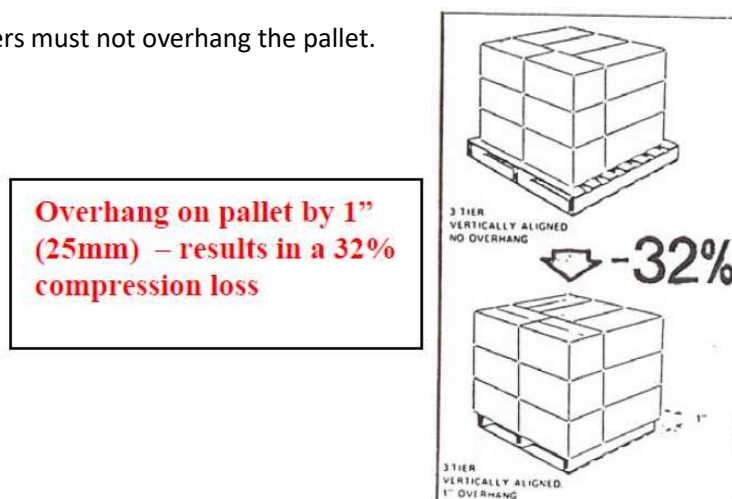

CONTAINER SIZE AND CONSTRUCTION continued

- Regular Slotted Containers (RSC) and Half Slotted Containers (HSC) may be used (see Attachment A1, A2, and A3).
- When HSCs are used, one common cover over each full layer of cartons on a pallet is the preferred method; although in some cases individual lids may be required. The use of uncovered (uncapped) HSCs is not acceptable.
- Corrugated material in shipping containers must have adequate strength to allow the parts to arrive at the using location in the same quality condition in which they were manufactured.
- A minimum 44 ECT/7.7kN/m (edge crush test) is required.
- Parts plus dunnage should completely fill the container to prevent collapsing because of excessive voids.
- Packaging materials coated or impregnated with wax or plastics must have prior authorization.
- All containers must be constructed with an outside tab style manufacturer's joint. A stitched manufacturer's joint is required if a glued or other type joint proves inadequate.
- All containers must have a box maker's certificate visible on the assembled container displaying edge crush (ECT) or bursting strength.
- The use of scored drop sides on palletized cartons may be required. Although normally on the longer side of the container, the location and size of the drop side is determined by part orientation and operator ergonomics. Consult your BWI Product Line Supplier Packaging Leader if further clarification is required.
- Wire bound wood pallet boxes or wood crates are not acceptable.
- Prior approval is required to use wood composite crates.
- Expendable container systems based on paper products, paperboard, fiberboard or similar materials must be designed to withstand an environmental atmosphere of 40 +/- 20C (104 +/- 4F) with a 85 +/- 5% relative humidity. Suggested pre-condition environment considers a temperature of 23 +/-1C (73 +/- 2F) with a 50 +/- 2% relative humidity
- Any other expendable container system must be designed to withstand temperature variations from (-) 29C to (+) 60C [(-) 20F to (+) 140F] with relative humidity variations up to 85 +/- 5%.

CONTAINER CLOSURE

Closure refers to the method in which containers must be sealed, after being filled, for shipping and handling. Containers must be adequately sealed to assure they do not open during shipping or handling. Taping or gluing is accepted for closure. Avoid staples for container closure. Packaging materials containing asphalt, such as asphalt sealing tapes are prohibited.

If any specific tool or methodology is required to open the container, it is mandatory to gain prior BWI approval.

CONTAINER SECUREMENT

All expendable containers shipped on pallets must be adequately secured to the pallets. Nails, screws, metal staples, metal strapping, metal clips or banding buckles, glue or PVC film to secure loads to pallets are prohibited.

The following are acceptable methods for securing cartons to a pallet:

- Plastic (Non-Metallic) Strapping –
 - A minimum of two vertical bands lengthwise and two vertical bands widthwise must be used.
 - Horizontal banding of corrugated boxes is prohibited.
 - Polyester strapping is required. BWI's Product Line Supplier Packaging Leader must approve use of any other strapping material.
 - Non-metallic strapping must be joined with a friction seal.
 - Metal clips, buckles, strapping require special arrangements with BWI

- Stretch film
 - Stretch film must be linear low-density polyethylene (LLDPE) and clear in color.
 - Stretch film must have enough clarity to enable bar code scanning of labels.
 - PVC film is not permitted.
 - A minimum of three layers of stretch film, or the equivalent in performance, are required around and encompassing the pallet.
Stretch film must securely capture the pallet when wrapping the bottom layer.

UNNACCEPTABLE DESIGN CHARACTERISTICS

- Pyramid stacking of containers disallowing load stacking.
- Misalignment of containers causing crushing.
- Use of “Do Not Stack” labels, which are prohibited.
- Overweight containers.
- Insufficient container strength to protect components.
- Multiple footprints disallowing standard loading patterns.

EXPORT / IMPORT REQUIREMENTS

Below are the general requirements to be followed when shipping parts from one country to another country:

- Supplier will monitor governmental & automotive industry regulations for changes related to packaging & shipping information.
- When shipping by airfreight, special reinforced packaging may be necessary.
- Packaging materials shall protect part quality for a minimum of **30 days for Intra-continent shipments and minimum of 90 days for Inter-continent shipments.**

5 RETURNABLE PACKAGING SYSTEMS

A returnable has a design and function permitting it to be used more than once in a defined supplier-customer system. All returnable containers will include a cardholder and/or a label placard. The tare weight must be stamped into the individual components of the container system.

BWI in EU has nominated CHEP as a strategic partner within our supply chain. CHEP will provide the Container Management Service for small reusable boxes called KLT and big bulk containers called FCLA. All CHEP KLT/FCLA containers are made from durable, recyclable plastic and are stackable. They are designed to be hand held and feature smooth interior walls to provide maximum strength, secure stacking and product protection. CHEP Automotive containers offer maximum cube usage and come clean and ready for use.

Any dunnage used in a KLT/FCLA must be expendable. BWI cannot guarantee the same KLT containers are consistently returned to a Supplier. All dunnage must be designed and purchased by the suppliers of components. More details regarding CHEP system you can find in below documents:

- **Full Service User Manual – CHEP’s**
- **AUTOMOTIVE Quality Manual New – CHEP’s**
- **SUPPLIER BRIEFING DOCUMENT – BWI’s Cheb, Krosno**
- **CHEP Supplier Document 2014 – BWI’s Luton**

MAINTENANCE, REPAIR AND CLEANING

BWI Responsibilities

- The BWI facility/CHEP, when shipping empty containers, will assure the containers are **clean**, free of debris and expendable packaging materials.
- The maintenance and repair procedures will be handled on an individual customer/supplier basis.

Supplier Responsibilities

- Load production parts into clean undamaged containers only and load the container systems into the transportation equipment in a manner that maintains part quality.
- Contact receiving plant’s material personnel for repair if a damaged container or pallet is detected. Remove damaged unit immediately from the system. To identify damage of CHEP packaging use “AUTOMOTIVE Quality Manual New”.
- Remove all one-time shipment labels on returnable packaging. The corrected labeling way for CHEP packaging is shown in document: “SUPPLIER BRIEFING DOCUMENT”
- Suppliers shall store containers in a manner, which allows ease of inventories, maintains cleanliness and protects parts and containers from excessive environmental exposure. Routine checks cleanliness and technical condition of returnable packaging to ensure part quality

RETURNABLE PACKAGING OWNERSHIP

BWI/CHEP Responsibilities

- Control the ownership/handling of returnable container systems.
- Maintenance, repair and cost of BWI owned systems.
- Coordinate any economic feasibility study to assure acceptable return on investment.
- Provide recommended returnable system.
- Approve system size and returnable system proposals.
- Provide disposition of obsolete/damaged containers.
- Provide instructions to container manufacturers on proper marking of the returnable containers and required documents in support of Customs special trade or tariff reduction programs. Returnable containers must include the markings “Container made in (country)” and a unique identifier such as the container number.

Supplier Responsibilities

- BWI returnable containers are to be used only for shipment of BWI products and are to be maintained in good order. Under no circumstances will damaged packaging be used for shipments to BWI facilities.
- Please refer to the BWI Group Supplier EDI Specifications, Despatch Advice for Advance Shipping Notice (DESADV), for any container identification and/or information requirements. Contact your BWI EDI Coordinator for the most recent edition of this specification.
- Maintain continuous shipping and receipt records of all BWI owned returnable packaging including:
 - Outbound shipments by container and location.
 - Supplier in-plant reserve.
 - Balance not returned from each BWI receiving location.
- Inspect all containers upon return and document any damaged containers.
- Contact the BWI receiving plant’s Production Control Department when shortages begin to occur.

6 INTERNAL DUNNAGE

Internal dunnage is considered to be a packaging components that requires a pallet or container to be shippable (e.g. vacuum formed trays, corrugated partitions, layer pads, etc.). Dunnage can be used in both returnable and/or expendable systems. Dunnage shall be used when part-to-part contact must be eliminated to prevent damage in shipping and handling or in cases where special part orientation as provided in your quote package is requested. Suppliers are responsible for the design, performance, and procurement of all expendable dunnage. Container loading, unloading, and waste recycling / disposal must be considered when designing interior dunnage. The use of dunnage constructed of combined and / or non-recyclable materials is discouraged.

7 SHIPPING LABELS

Below are the general requirements to be followed when labeling:

- Supplier is responsible to ensure correct labeling is provided for all packaging. Review the

label standards in BWI ODETTE CONTAINER LABEL REQUIREMENTS STANDARD:

<http://www.bwigroup.com/wp-content/uploads/2017/09/BWI-Odette-Supplier-Label-specs-v1.pdf>

- Labels must be legible.
- All labels must be electric scanner compliant.
- If placards are available on containers, use this area to apply shipping labels.
- Any deviations must be reviewed and approved by the receiving BWI's Plant Production Control.
- Where container size does not adequately provide for the use of standard shipping labels, contact the appropriate approver listed within the BWI AIAG CONTAINER LABEL and BWI ODETTE CONTAINER LABEL

8 MIXED LOADS

A mixed load occurs when more than one part number is shipped on a pallet. (Note: Loads should never be mixed in a bulk container system.) A mixed load should be considered mainstream when frequency of delivery requires less than full pallet loads. This also allows better cube utilization of the transportation system. When shipping a mixed load the following requirements must be met:

- A mixed load label must be affixed to the load on two adjacent corners where the shipping label is normally attached. In addition, a mixed load manifest or packing slip must be attached to the load that indicates the part numbers shipped and how many containers are associated with each part number.
- The packing slip will designate the entire contents of the load.
- Similar part numbers will be grouped together on the pallet for ease of identification and accountability.
- The mixing of containers on a single skid destined for different plants or delivery docks is not allowed.
- The containers must be positioned on the pallet so the label faces the outside perimeter of the pallet for ease of identification. When possible, all labels should be visible to ease identification and accountability requirements.
- Care should be taken to balance the load by distributing the weight as evenly as possible, remembering that similar products must be grouped.
- The load may require special attention to secure the containers if void and or irregular configuration occurs. Stretch wrap is the preferred method.
- Level layers are the requirement. This allows better cube utilization of the transportation system. Mixed loads may be necessary in order to achieve this condition. A “mixed load” may have the following conditions:
 - Single or multiple part number(s) on a pallet mixed w/ empty containers.
 - Multiple part numbers on a pallet.
- Guidelines for mixing loads:
 - If the BWI receiving facility is ordering the material in pallet quantities – mixed loads are not allowed unless receiving facility has authorized.
 - If the BWI receiving facility is ordering the material by box (carton) quantity – then mixing loads is permissible.
 - A MASTER label for each part number and a MASTER label must be present on the pallet, indicating pallet contents.
 - When mixing part numbers on a pallet, the heaviest parts must be placed on the bottom layer.

9 SHIPPING PARTIAL LAYERS

Guidelines for shipping partial layers:

The partial layer is to be completed using empty boxes. Empties may only be on top layer and must be identified as EMPTY. A mixed load label is required if there are full and empty boxes on the same pallet. .

Do not mix bulk on the same pallet. Manually handled boxes can be mixed on one pallet.

10 SHIPPING STANDARDS

The following is general shipping information for BWI Suppliers using BWI's Lean Logistics Network (LLN):

- Make dock door available per the scheduled window time.
- Shipment of material is to be on the BWI specified carrier unless otherwise authorized by BWI plant or its Lean Logistics Provider prior to shipment.
- Allow the Route Manager (carrier driver) access to the dock for load verification and loading supervision.
- Stage material for the route manager to inspect:
 - There must be sufficient access for the route manager to verify part numbers and piece counts. All identifying labels are to be facing outward so that such identification can be made. If the condition exists where a label is not visible to the Route Manager (i.e.: 12 containers on a layer – the center containers can not be seen), then a “Master Label” must be placed on the outside of the load so that the Route Manager can verify each load’s part number and piece count.
 - Product will NOT be loaded until Route Manager has verified the material being shipped, to the carrier manifest, and gives approval to do so.
- Execute Route Manager’s directions for loading and stacking material in the trailer. Directions may include:
 - Instructions to handle and stack another suppliers’ material (already on the trailer) to maximize trailer utilization.
 - Stacking of different suppliers’ material whenever feasible (assure top pallet is of the same or smaller footprint as lower pallet footprint).
- Suppliers may also have to handle other suppliers’ empty containers being returned on the route requiring:
 - Unload all empty containers from the trailer before loading supplier’s material.
 - After loading supplier’s material onto the trailer, reload empty containers back onto the trailer as directed by the route manager.
 - Route manager is responsible to account for all pallets removed.
- For empty containers being returned to the supplier, the following is to be done: Confirm quantity against shipping manifest, check for damage, and sign for receipt of the containers.
 - If received quantity does not match the manifest, correct the information and obtain route manager’s signature. Notification must be made to the shipping BWI facility of the count difference.

11 PACKAGING EXAMPLES

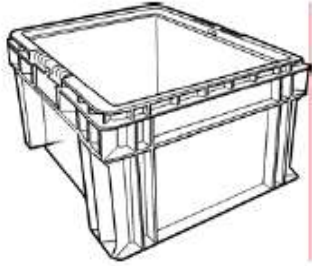

Manually Handled Returnable

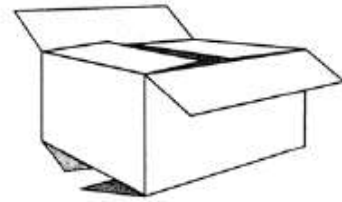

Manually Handled Expendable

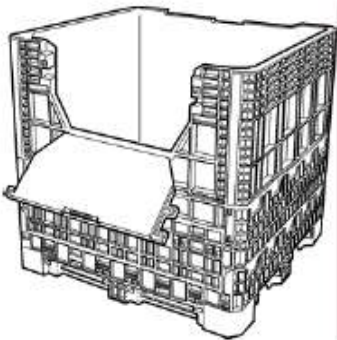

Bulk Returnable

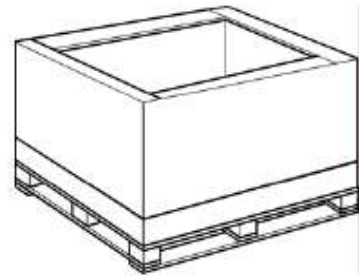

Bulk Expendable

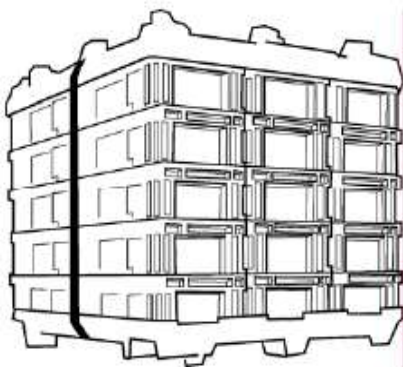

Palletized Load Returnable

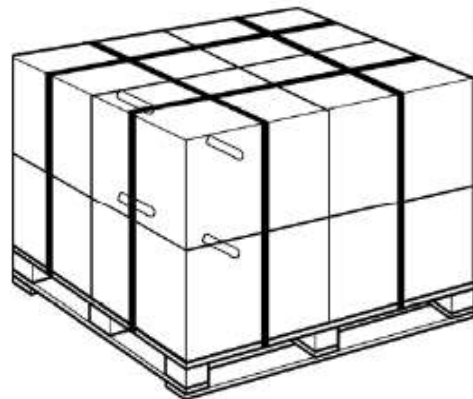

Palletized Load Expendable







12 RECYCLING INFORMATION



Resin Identification Codes

To facilitate the recycling of a product, its identity must be known. There are numerous types of plastics used for automotive packaging which require a simple method of identification. BWI will require the Resin Identification Codes; the same as on retail packaging. The resin identification code chart is shown below. All vacuum-formed and injection-molded plastic packaging material must be identified by this code.

NOTE: Plastic components that are assembled to the vehicle are to be identified with the proper resin identification code to facilitate recycling. Packaging material must be marked with the appropriate resin identification code.

Recycling Number	Abbreviation	Polymer Name
 PETE <small>Image</small>	PETE or PET	Polyethylen Terephthalate
 HDPE <small>File</small>	HDPE	High Density Polyethylene
 V <small>File</small>	PVC or V	Polyvinyl Chloride
 LDPE <small>Image</small>	LDPE	Low-Density Polyethylene
 PP	PP	Polypropylene
 PS	PS	Polystyrene
 OTHER	OTHER	Other plastics including acrylic, polycarbonate, polylactic acid, nylon and fiberglass.



WASTEFUL, EXCESSIVE, OR NON-RECYCLABLE MATERIAL

Packaging is required to serve many needs; part protection, transportation effectiveness, lean manufacturing, and ergonomic and environmental concerns to name a few. Proposed and impending state and federal legislation is prohibiting wasteful and/or excessive packaging. The challenge is to meet these requirements with the amount and degree of packaging necessary and no more. Over-packaging and wasteful “just-in-case” packaging is undesirable for both the supplier and the user. Each BWI supplier is expected to identify and correct such packaging on an ongoing basis.

**With reduction or elimination as the first priority,
the hierarchy of waste elimination is:
REDUCE →→→ REUSE →→→ RECYCLE**

To list every example of wasteful, excessive or non-recyclable packaging would be too extensive. We have identified a few examples that have been significant problems at the plants.

- Cartons partially filled.
- Oversized foam, plastic or corrugated dunnage.
- Micro cellular foam wrap and bubble wrap.
- Plastic protective covers, caps, plugs, paint masks or spacers required in the manufacturing process, but not required as a protective shipping device.
- Corrugated carton test strength that far exceeds requirements.

Non-recyclable packaging is that which has no available or economical system in place to process an item. Wax-coated corrugated is a prime example of this type of packaging. Waxed- or plastic-coated paper is prohibited, unless otherwise directed by BWI.

Plastic plugs, caps, and protectors are extremely difficult to recycle due to oil and paint contamination, colors, uncertainty of resin type, and transportation costs. Every effort should be made to eliminate the plastic. If it cannot be eliminated, other changes can be made to assist the plants’ recycling efforts.

- Mold the appropriate plastic recycling code into the part. When elimination is not possible, these codes will allow for effective recycling.
- Clear LDPE plastics are preferred and can be effectively recycled.
- Ship plastics uncontaminated with paints and lubricants.
- Replace the plastic with a paper substitute.

Any plastic cap, plug, spacer, etc. not required for packaging or shipping protection must be removed prior to shipment.

13 FORMS AND SUPPLEMENT REQUIREMENTS

Attachment A1: Standard Container Menu: North American Standards

Attachment A2: Standard Container Menu: International Standards

Attachment A3: Standard Container Menu: North American Standard Returnables

Attachment A4: Standard Pallet Menu: North American & International Standards

Attachment A5: Standard Packaging Materials: Miscellaneous Materials – tape, stretch film, layer pads, banding, partitions, corner boards, spools, reels, etc.

Attachment B: BWI Supplier Packaging Information Form (SPI)

Attachment C: Cube Utilization

Attachment D: Supplier Packaging Selection Checklist

Attachment E: Supplier Ship Compliance Checklist

Attachment F: Packaging Receiving Checklist

References (available at most libraries and bookstores):

ASTM (American Society for Testing and Materials)
ISTA (International Safe Transit Association)
ISPM (International Standards for Phytosanitary Measures)
SPI (Society of Plastics Industry)

Attachment A1 – Standard Container Menu: North American Standards

Expendable Manually Handled Containers

Outside Dimensions		Pallet Size	Containers per Layer	Max. # Layers on Secondary Container	Tare Weight (lbs)	Container Type	Inside Dimensions		
Inches	Millimeters						Length	Width	Depth
Regular Slotted Cartons (RSC)									
9 x 9 x 4	229 x 229 x 102	48 x 45	25	11					
9 x 9 x 6	229 x 229 x 153	48 x 45	25	7					
12 x 7.5 x 3.75	305 x 191 x 102	48 x 45	24	11	0.4	RSC	11-5/8	7-1/8	3-1/8
12 x 15 x 3.75	305 x 381 x 102	48 x 45	12	11	0.9	RSC	11-5/8	14-5/8	3-1/8
12 x 15 x 7.5	305 x 381 x 191	48 x 45	12	6	1.1	RSC	11-5/8	14-5/8	6-7/8
24 x 15 x 3.75	610 x 381 x 102	48 x 45	6	11	1.3	RSC	23-5/8	14-5/8	3-1/8
24 x 15 x 7.5	610 x 381 x 191	48 x 45	6	6	1.5	RSC	23-5/8	14-5/8	6-7/8
24 x 15 x 11.25	610 x 381 x 280	48 x 45	6	4	1.8	RSC	23-5/8	14-5/8	10-5/8
24 x 15 x 14.5	610 x 381 x 369	48 x 45	6	3	2.0	RSC	23-5/8	14-5/8	13-7/8
24 x 22.5 x 7.5	610 x 572 x 191	48 x 45	4	6	2.4	RSC	23-5/8	22-1/8	6-7/8
24 x 22.5 x 11.25	610 x 572 x 280	48 x 45	4	4	2.7	RSC	23-5/8	22-1/8	10-5/8
24 x 22.5 x 14.5	610 x 572 x 369	48 x 45	4	3	3.1	RSC	23-5/8	22-1/8	13-7/8
Half Slotted Cartons (HSC)									
11-11/16 x 7-7/16 x 3-11/16	281 x 189 x 93.7	48 x 45	24	11	0.3	HSC	11-1/4	7	3-1/16
11-11/16 x 14-7/8 x 3-11/16	281 x 200 x 93.7	48 x 45	12	11	0.5	HSC	11-1/4	14-7/16	3-1/16
11-11/16 x 14-7/8 x 7-3/8	281 x 200 x 187.3	48 x 45	12	6	0.7	HSC	11-1/4	14-7/16	6-3/4
23-7/16 x 14-7/8 x 3-11/16	595.3 x 200 x 93.7	48 x 45	6	11	0.8	HSC	23	14-7/16	3-1/16
23-7/16 x 14-7/8 x 7-3/8	595.3 x 200 x 187.3	48 x 45	6	6	1.0	HSC	23	14-7/16	6-3/4
23-7/16 x 14-7/8 x 11-1/16	595.3 x 200 x 281	48 x 45	6	4	1.3	HSC	23	14-7/16	10-7/16
23-7/16 x 14-7/8 x 14-3/4	595.3 x 200 x 374.7	48 x 45	6	3	1.5	HSC	23	14-7/16	14-1/8
23-7/16 x 22-5/16 x 7-3/8	595.3 x 566.7 x 187.3	48 x 45	4	6	1.5	HSC	23	21-7/8	6-3/4
23-7/16 x 22-5/16 x 11-1/16	595.3 x 566.7 x 281	48 x 45	4	4	1.9	HSC	23	21-7/8	10-7/16
23-7/16 x 22-5/16 x 14-3/4	595.3 x 566.7 x 374.7	48 x 45	4	3	2.2	HSC	23	21-7/8	14-1/8
HSC Layer Covers									
12-13/16 x 7-13/16 x 2	325.4 x 198.4 x 50.8				0.23	Cover	11 11/16	7 7/16	2.0
16 x 12-1/16 x 2	406.4 x 306.4 x 50.8				0.37	Cover	14 7/8	11 11/16	2.0
24-9/16 x 15-1/4 x 2	623.9 x 387.4 x 50.8				0.59	Cover	23 7/16	14 7/8	2.0
24-9/16 x 22-11/16 x 2	623.9 x 576.3 x 50.8				0.82	Cover	23 7/16	22 5/16	2.0
48 x 45 x 3	1219.2 x 1143 x 76.2				2.8	Cover	46-7/8	44-5/8	3.0

Attachment A2 – Standard Container Menu: International Standards

Manually Handled Containers

Expendable Carton (MM)	Returnable Container (MM)	Pallet Size (MM)	Containers per Layer
International Standards			
	200 x 150 x 140	600 x 800	
300 x 200 x 150	297 x 198 x 148 VDA	1200 x 800	16
300 x 200 x 150	300 x 200 x 114 Galia	1200 x 800	16
300 x 200 x 200	300 x 200 x 214 Galia	1200 x 800	16
400 x 300 x 150	396 x 297 x 148 VDA	1200 x 800	8
400 x 300 x 150	400 x 300 x 114 Galia	1200 x 800	8
400 x 300 x 200	396 x 297 x 280 VDA	1200 x 800	8
400 x 300 x 200	400 x 300 x 214 Galia	1200 x 800	8
400 x 300 x 300	400 x 300 x 280 Galia	1200 x 800	8
600 x 400 x 200	594 x 396 x 280 VDA	1200 x 800	4
600 x 400 x 200	600 x 400 x 214 Galia	1200 x 800	4
600 x 400 x 300	600 x 400 x 314 Galia	1200 x 800	4

Preferred Pallet Sizes (MM)
1200 x 800
1200 x 1000

Acceptable Pallet Sizes (MM) (requires prior approval)
600 x 800
600 x 1000

Bulk Containers (MM)
800 x 600 x 465
1200 x 1000 x 860
1200 x 1000 x 975

This listing provides rightsized standards for returnable and expendable containers. The dimensions shown should be considered outside dimensions.

Attachment A3 – Standard Container Menu: North American Standard Returnables

Manually Handled Returnable Containers

	IN	MM	Pallet Size	Containers per Layer	Max. # Layers on Secondary Container	Tare Weight (lbs)	Material	
	North American Standards							
	12 x 7.5 x 4	305 x 191 x 102	48 x 45	24	11	1.1	HDPE	
	12 x 15 x 4	305 x 381 x 102	48 x 45	12	11	2.0	HDPE	
	12 x 15 x 7.5	305 x 381 x 191	48 x 45	12	6	2.7	HDPE	
	24 x 15 x 4	610 x 381 x 102	48 x 45	6	11	3.0	HDPE	
R	24 x 15 x 7.5	610 x 381 x 191	48 x 45	6	6	4.6	HDPE	
	24 x 15 x 11	610 x 381 x 280	48 x 45	6	4	5.0	HDPE	
32	24 x 15 x 14.5	610 x 381 x 369	48 x 45	6	3	8.3	HDPE	all id
32	24 x 22.5 x 7.5	610 x 572 x 191	48 x 45	4	6	6.9	HDPE	
48	24 x 22.5 x 11	610 x 572 x 280	48 x 45	4	4	7.3	HDPE	
48	24 x 22.5 x 14.5	610 x 572 x 369	48 x 45	4	3	11.3	HDPE	

Attachment A4 – Standard Pallet Menu: North American & International Standards

Pallet Name	Size	Type	Material	Notes
Standard Pallets				
Standard Light Duty	48in x 45in x 5in (1220mm x 1140mm x 130mm)	4 way wing	Wood: Heat treated; ISPM#15	For loads < 500lbs
Standard Light Duty (Europe)	800mm x 1200mm x 145mm	4 way	Wood: Heat treated; ISPM#15	For loads < 500kg
Standard Heavy Duty	48in x 45in x 5in (1220mm x 1140mm x 130mm)	4 way flush	Wood: Heat treated; ISPM#15	For loads > 500lbs
Standard Industry	48in x 40in x 5in (1220mm x 1015mm x 130mm)	4 way flush	Wood: Heat treated; ISPM#15	May use for 1200mm x 1000mm
Standard Oversize	48in x 45in x 5in (1220mm x 1140mm x 130mm)	4 way flush	Wood: Heat treated; ISPM#15	For Delphi Powertrain and Delphi E&S
Standard Half	24in x 46in x 5in (610mm x 1170mm x 130mm)	2 way flush	Wood: Heat treated; ISPM#15	Standards for fiberboard cable & barrels
Standard Half (Europe)	600mm x 800mm x 130mm	2 way flush	Wood: Heat treated; ISPM#15	
Standard Corrugated	48in x 45in x 4-3/8in (1220mm x 1140mm x 111mm)	4 way flush	Corrugated	One time use, non-harsh environment For loads < 500lbs
Alternate Corrugated	48in x 45in x 4-1/4in (1220mm x 1170mm x 108mm)	4 way die cut	Corrugated	One time use, waxed for moist (not wet) environment. For loads < 500lbs
Alternate Approved Pallets				
Fastener Industry	32in x 30in x 5in (810mm x 760mm x 130mm)	4 way	Wood: Heat treated; ISPM#15	Standard pallet used for 9 x 9 footprint boxes
Alternate Light Duty (Europe)	1200mm x 1000mm x 145mm	4 way	Wood: Heat treated; ISPM#15	For loads < 500kg
Alternate Light Duty	32in x 36in x 5in (810mm x 915mm x 130mm)	4 way	Wood: Heat treated; ISPM#15	For loads < 500lbs

Attachment A5 – CHEP packaging types for EU

CHEP Equipment Code		R-KLT 3215 00811	R-KLT 4315 00810	R-KLT 4329 00809	R-KLT 6415 00818	R-KLT 6429 00808
Description	A durable, stackable, recyclable plastic crate with label holders. To VDA specification.					
Dimensions	External (mm)	297 x 198 x 147.5	396 x 297 x 147.5	396 x 297 x 290	594 x 396 x 147	594 x 396 x 280
	Internal Usable (mm)	243 x 162 x 129.5	346 x 265 x 109.5	346 x 265 x 242	544 x 364 x 111	544 x 364 x 242
	Tolerances:					
	Length & Width	+0/-0.8%	+0/-0.8%	+0/-0.8%	+0/-0.8%	+0/-0.8%
	Height	±1 mm	±1 mm	±1 mm	±1 mm	±1 mm
	Usable volume	5.3 litres	10.1 litres	22.3 litres	21.7 litres	48 litres
Weight		0.56 kg	1.29 kg	1.85 kg	2.1 kg	2.97 kg
		Tolerance ±1%	Tolerance ±1%	Tolerance ±1%	Tolerance ±1%	Tolerance ±1%
Material	Polypropylene, blue to RAL 5003					
Load Capacity	20 kg					
Unit Load Information	R-KLTs per Pallet	60	60	30	30	15
	Pallet Size (mm)	600 x 1000	1000 x 1200	1000 x 1200	1000 x 1200	1000 x 1200
	CHEP Pallet Code	00062	00060	00060	00060	00060
	Unit Load Cover (mm)	600 x 1000	1000 x 1200	1000 x 1200	1000 x 1200	1000 x 1200
	CHEP Cover Code	00063	00061	00061	00061	00061
Temperature Range	-20° C to +60° C					
Stacking	Single R-KLTs can be stacked up to 12 high loaded on a level and solid base					
Banding	Unit loads should be banded for transportation using two plastic bands					



CHEP Equipment Code	00048 for FLC 121097 and 00801 for FLC 121060		
Description	FLC 121097: Folding pallet container with two access doors and four-way entry base FLC 121060: Folding pallet container with four-way entry base		
Dimensions		FLC 121097	FLC 121060
	External Erected (mm)	1200x1000x975	1200x1000x595
	Internal Erected (mm)	1110x910x792	1110x910x413
	Internal Usable Height	755 mm	376 mm
	Folded (mm)	1200x1000x406	1200x1000x406
Usable Volume (cu.mtrs)	0.76	0.38	

Attachment B – BWI Supplier Packaging Information Form (SPI) – Example Only



SUPPLIER PACKAGING INFORMATION

BWI PROVIDED INFORMATION: Initial Submission Change

BWI CONTRACT NAME Magdalena Mysza	CONTACT PERSON/PHONE 45124371155	EMAIL/PO magdalena.mysza@bwi.com	DATE SUBMITTED 15.12.2017
SPD #/ORD	SPD/ORDER CONTAINER CHSP 396 x 287 x 280	SPD/BACK QTY 54 pcs	BACK OPTION <input type="checkbox"/> Expandable <input checked="" type="checkbox"/> Returnable
SPECIAL PACKAGING REQUIREMENTS Part Cleanliness is an Issue / Bags or Disposable Liners are Required / VCI Paper or Desiccant is Required / A Returnable Container is Required / Ergonomic Weight Limit is LESS THAN the 20 kg General Guideline / Load Must be Secured with Banding /			
Component need to be dry and clean. Oil protection is not allowed - special agreements with BWI needed. Place VCI bag with details Place approximately 54 parts per R-KLT 4222 This applies to the following P/Ns: 22263606		SPD/WEIGHT 129g	<input type="checkbox"/> Additional Requirements Attached

RETURNABLE PACK REQUESTED: provide INFO and PRICING for BOTH the Returnable and Expandable pack options /

SUPPLIER PROVIDED INFORMATION: Initial Submission Change

SUPPLIER COMPANY NAME Ortwin G.V.	CONTACT NAME Rik Meertoom	CONTACTPHONE NUMBER +31 46 46 70 517	EMAIL/PO rik.meertoom@ortwin.nl
COMPANY ADDRESS Schubertstrasse 17	SHIPPING ADDRESS (IF DIFFERENT) Raffineriestrasse 2, 25152 Vechelde Germany		DATE
PROGRAM/MODEL/VERSION	PART DESCRIPTION Inner spring Ring 124.2x150mm		PART NUMBER 124.2 x 2 x 15 mm
PART NUMBER(S) 22263606	VOLUME	SHIP METHOD <input type="checkbox"/> Daily <input checked="" type="checkbox"/> Other	

RETURNABLE PACK INFORMATION	EXPENDABLE MATERIAL COST PER PIECE (EUR)																											
<table border="1" style="width: 100%; border-collapse: collapse;"> <tr> <td style="width: 20%;">SECONDARY CONTAINER TYPE (n/a)</td> <td style="width: 5%;">D+</td> <td style="width: 15%;">SPD</td> <td style="width: 10%;">TUBE FIT</td> <td style="width: 10%;">LIDS REQUIRED YES</td> <td style="width: 40%;">MATERIAL (n/a)</td> </tr> <tr> <td>CONTAINER TYPE (n/a)</td> <td>D+</td> <td>SPD</td> <td>TUBE FIT</td> <td>LIDS REQUIRED</td> <td>MATERIAL (n/a)</td> </tr> <tr> <td>CONTAINER TYPE (n/a)</td> <td>D+</td> <td>SPD</td> <td>TUBE FIT</td> <td>LIDS REQUIRED</td> <td>MATERIAL (n/a)</td> </tr> <tr> <td>SECONDARY CONTAINER TYPE (n/a)</td> <td>D+</td> <td>SPD</td> <td>TUBE FIT</td> <td>LIDS REQUIRED</td> <td>MATERIAL (n/a)</td> </tr> </table>	SECONDARY CONTAINER TYPE (n/a)	D+	SPD	TUBE FIT	LIDS REQUIRED YES	MATERIAL (n/a)	CONTAINER TYPE (n/a)	D+	SPD	TUBE FIT	LIDS REQUIRED	MATERIAL (n/a)	CONTAINER TYPE (n/a)	D+	SPD	TUBE FIT	LIDS REQUIRED	MATERIAL (n/a)	SECONDARY CONTAINER TYPE (n/a)	D+	SPD	TUBE FIT	LIDS REQUIRED	MATERIAL (n/a)	STANDARD PACK QUANTITY: NO OFFPRIMARY CONTAINER/RELIVER, NO OFFLIDERS OVER SECONDARY CONTAINER.			
SECONDARY CONTAINER TYPE (n/a)	D+	SPD	TUBE FIT	LIDS REQUIRED YES	MATERIAL (n/a)																							
CONTAINER TYPE (n/a)	D+	SPD	TUBE FIT	LIDS REQUIRED	MATERIAL (n/a)																							
CONTAINER TYPE (n/a)	D+	SPD	TUBE FIT	LIDS REQUIRED	MATERIAL (n/a)																							
SECONDARY CONTAINER TYPE (n/a)	D+	SPD	TUBE FIT	LIDS REQUIRED	MATERIAL (n/a)																							
PART WEIGHT	PRIMARY CONTAINER HEIGHT	SECONDARY CONTAINER HEIGHT	METHOD TO SECURE LOAD (n/a)	MATERIAL (n/a)																								

EXPENDABLE PACK INFORMATION	EXPENDABLE MATERIAL COST PER PIECE (EUR)																											
<table border="1" style="width: 100%; border-collapse: collapse;"> <tr> <td style="width: 20%;">SECONDARY CONTAINER TYPE (n/a)</td> <td style="width: 5%;">D+</td> <td style="width: 15%;">SPD</td> <td style="width: 10%;">TUBE FIT</td> <td style="width: 10%;">LIDS REQUIRED</td> <td style="width: 40%;">MATERIAL (n/a)</td> </tr> <tr> <td>CONTAINER TYPE (n/a)</td> <td>D+</td> <td>SPD</td> <td>TUBE FIT</td> <td>LIDS REQUIRED</td> <td>MATERIAL (n/a)</td> </tr> <tr> <td>CONTAINER TYPE (n/a)</td> <td>D+</td> <td>SPD</td> <td>TUBE FIT</td> <td>LIDS REQUIRED</td> <td>MATERIAL (n/a)</td> </tr> <tr> <td>SECONDARY CONTAINER TYPE (n/a)</td> <td>D+</td> <td>SPD</td> <td>TUBE FIT</td> <td>LIDS REQUIRED</td> <td>MATERIAL (n/a)</td> </tr> </table>	SECONDARY CONTAINER TYPE (n/a)	D+	SPD	TUBE FIT	LIDS REQUIRED	MATERIAL (n/a)	CONTAINER TYPE (n/a)	D+	SPD	TUBE FIT	LIDS REQUIRED	MATERIAL (n/a)	CONTAINER TYPE (n/a)	D+	SPD	TUBE FIT	LIDS REQUIRED	MATERIAL (n/a)	SECONDARY CONTAINER TYPE (n/a)	D+	SPD	TUBE FIT	LIDS REQUIRED	MATERIAL (n/a)	STANDARD PACK QUANTITY: NO OFFPRIMARY CONTAINER/RELIVER, NO OFFLIDERS OVER SECONDARY CONTAINER.			
SECONDARY CONTAINER TYPE (n/a)	D+	SPD	TUBE FIT	LIDS REQUIRED	MATERIAL (n/a)																							
CONTAINER TYPE (n/a)	D+	SPD	TUBE FIT	LIDS REQUIRED	MATERIAL (n/a)																							
CONTAINER TYPE (n/a)	D+	SPD	TUBE FIT	LIDS REQUIRED	MATERIAL (n/a)																							
SECONDARY CONTAINER TYPE (n/a)	D+	SPD	TUBE FIT	LIDS REQUIRED	MATERIAL (n/a)																							
PART WEIGHT	PRIMARY CONTAINER HEIGHT	SECONDARY CONTAINER HEIGHT	METHOD TO SECURE LOAD (n/a)	MATERIAL (n/a)																								

Attachment C – Supplier Packaging Selection Checklist

To assure BWI’s packaging requirements are followed, refer to this pack selection checklist for guidance. Note: Failure to meet BWI’s requirements is a breach of supplier responsibility. BWI Packaging Management must approve all exceptions.

- 1. **BWI Global Packaging and Shipping Manual** available and understood

- 2. Shipping containers selected from Standard Container Menu and Standard Pallet Menu

- 3. Selected shipping container of sufficient strength to contain products through entire material movement cycle (ex: storage, transportation & material handling)

- 4. Knowledge of final destination of product sold to BWI and assures compliance with all government regulations

- 5. All pertinent supplier employees trained regarding BWI’s shipping and packaging requirements

- 6. Container supplier selected who understands and complies with BWI’s packaging requirements

- 7. Have a SPI form submitted and maintain a copy for each part number supplied to BWI

Attachment D – Supplier Ship Compliance Checklist

To assure BWI’s packaging requirements are followed, please follow this ship compliance checklist for guidance. Note: Failure to meet BWI’s requirements is a breach of supplier responsibility. BWI Packaging Management must approve all exceptions.

- 1. Approved SPI for each container and pallet are used for shipment.

- 2. Containers are palletized, aligned (not brick stacked), do not overhang the pallet, and are supported by the deck boards.

- 3. All labels are applied per labeling requirements and mixed load labels are used as necessary. DO NOT STACK labels are NOT used.

- 4. All pallets are cubed and have leveled layers (no pyramids or voids).

- 5. Containers are secured to the pallet with approved stretch film (min 3 wraps) or approved plastic strapping (min 2 length, 2 width) and no metal is used.

- 6. All shipping documents are attached to the load in a document pouch: commercial invoice, packing slip, wood certification (as required) or given to Route Manager in the case of truck loads or milk runs.

Attachment E – Packaging Receiving Checklist

To assure incoming shipments adhere to BWI's shipping rules; this checklist should be used as a random audit by the 1st BWI controlled location (cross dock or plant dock) that handles it. Compliance failures will be communicated to the supplier and immediate corrective action will be required at the supplier's expense.

1. **Uniform layers – Must be stackable -- no pyramid loads; maximum height of 52".**
2. **Product packaging must not overhang the pallet.**
3. **All products (cartons, reels, drums, etc.) must be securely attached to pallet.**
4. **Each package or pallet-load needs to have an affixed label consisting of:**
- | | |
|-----------------------------------|--------------------------------------|
| a. BWI Part Number | j. Engineering Change/Revision Level |
| b. Part description | k. Lot Number |
| c. Quantity | l. Destination Location |
| d. Shipper name | m. Manufacturing Date |
| e. Shipment Identification Number | n. Serial Number |
| f. Supplier Ship from Duns Number | o. Storage/Bin Location |
| g. Country of origin | p. Consignee name |
| h. Shipment date | q. No. of cartons per pallet/skid |
| i. Purchase order number | |
5. **Documentation Requirements - Each Shipment (commercial invoice) needs the following:**
- a. **Packing List**
 - b. **Invoice – should state the country of origin & Ultimate destination**
 - c. **Wood Certification document. should be issued as follows:**
 1. **Corrugated, Plastic, or mfg wood : No-Wood Document**
 2. **Softwood / Hardwood :Coniferous / Non-coniferous Document**
 - d. **Documents must be ATTACHED to the outside of the packaging**

GLOSSARY OF TERMS

Adhesive - A material capable of attaching one surface to another. As used in connection with fibre boxes; a material to glue plies of solid fibreboard, to glue facings to corrugating medium in combined corrugated board, to glue the overlapping sides of a box forming the manufacturer's joint or to glue the flaps in closing a slotted box.

Box (Carton) - A rigid container having closed faces and completely enclosing its contents.

Box Maker - Corrugated or solid fibre box manufacturing establishment which has equipment to score, slot, print and join corrugated or solid fibre sheets into boxes, which equipment is regularly utilized in the production of fibre boxes in commercial quantities.

Brick Stacking - Act of alternating the stacking of containers on pallets, length by width and width by length.

Bursting Strength - The strength of material expressed in pounds per square inch.

Closure - The method used to seal a container once the parts have been packaged within it.

Containerization - Packaging parts in the smallest lot possible resulting in presentation of a quality part to eliminate waste of motion for the manufacturing operator. Note: The best container for the operator is no container.

Containment - Contain the product from point of manufacture until delivery at its point of use.

Cross Stack – A feature molded into the bottom of returnable manually handled container that allows a larger container to stack on top a number of smaller containers.

Deck - The horizontal load-carrying or load-bearing surface of a pallet.

Deck Opening - Any void in the deck caused by the spacing of surface elements or a cutout in a solid deck pallet.

Deckboard - The surface element used in the construction of a pallet deck.

Distribution Environment – The entire material flow process from supplier through user.

Duns Number - A number designation code assigned to shippers by Dun & Bradstreet.

Dunnage - Devices or materials used to hold, secure, or protect goods during shipment.

Expendable – A pack that makes only one trip.

Edge Crush Test (ECT) – Corrugated board test to determine the force that will crush a standard size of board standing on an edge. ECT indicated the probable compression strength of the container made from the board.

Footprint - The outermost dimensions (length and width) of a pallet, container or container system.

Four-way Pallet - A pallet constructed to allow insertion and withdrawal of handling equipment from all sides of the pallet.

Height -The overall dimension of the container in the vertical direction.

Half Slotted Container - Same as Regular Slotted Container without one set of flaps (a box which requires a separate lid).

Joint - That part of the box where the ends of the scored and slotted blank are jointed together by taping, stitching, or gluing. When accomplished in the box manufacturer's plant, it is known as a manufacturer's joint; when effected at the time the box flaps are sealed in a box user's plant (usually on automatic equipment), it is called a user's joint.

Lean Logistics Network – A centralized consolidated logistics system that manages and optimizes the BWI North American material movement. The purpose is to increase efficiency in material delivery, increase delivery frequency, leverage the overall BWI volume to reduce the North American cost structure while providing planned, predictable material delivery. Deliver the right part, in the right quantity at the right time.

Mixed Load – more than one part number shipped on/or in a single secondary container.

Overhang - That portion of the unit load that exceeds the width or length dimension of a pallet. (Not allowable).

Pack Validation –The process used to test the basic functions of containment and protection.

Pad - A corrugated or solid fibreboard sheet or other authorized material used for extra protection or for separating tiers or layers of articles when packed for shipment.

Pallet - A horizontal platform device used as a base for assembling, storing, handling, and transporting materials and products in a unit load.

Performance - Perform in various ways for enabling packing, handling, storage, transportation, unpacking, disposal, etc.

Placard – An easy release label or card holder area affixed to a container for the purpose of placing a label or kanban card.

PPAP -Production Part Approval Process.

Primary Container - The shippable container closest to the parts.

Protection – To protect the product from various hazards encountered in the distribution environment.

Returnable – A pack that makes multiple trips.

Rightsizing - Containerization that optimizes the entire material flow process from supplier to user.

Regular Slotted Container -Corrugated box where all flaps have the same length, and the two outer flaps (normally the lengthwise flaps) are one-half the container's width, so that they meet at the center of the box when folded.

SCR (Supplier Change Request) – Used to submit supplier cost savings suggestions and ideas to BWI.

Score - Impression or crease in corrugated or solid fibreboard to locate and facilitate folding. (See also Slit-Score).

Seam - The junction created by any free edge of a container flap or wall where it abuts or rests on another portion of the container and to which it may be fastened by tape, stitches or adhesives in the process of closing the container.

Secondary Container - Larger container on which multiple primary containers are shipped.

Secondary Container Length – Length of the secondary container. For wood pallets, it is the dimension of the stringers or stringer boards.

Secondary Container Width – Width of the secondary container. For wood pallets, it is the dimension of the top deck boards of a pallet.

Standard Pack - The Primary Container.

Standard Pack Quantity -Number of pieces in a shippable primary container.

Stitching or Stapling - Application of metal fasteners to form the joint of fibre boxes or to close boxes. Stitches are machine-formed using wire drawn from a spool. Staples are performed.

Stringer - A continuous longitudinal board member of a pallet that supports the horizontal load-carrying or load-bearing surface.

Tape - A strip of cloth or paper, sometimes having a filler or reinforcement, coated on one side with an adhesive. It is used to form the joint on a fibre box or to close or reinforce such a box. Closure and reinforcement can also be affected with pressure-sensitive tape.

Tare Weight - Weight of the container(s), excluding the weight of the parts.

Test; Bursting Strength (Mullen) - Measurement of the resistance of a material to bursting

expressed in pounds per square inch. The test is made on a motor-driven Mullen tester.

Top Deck - Load-carrying surface.

Unit Load Height – The overall height of the primary containers when stacked on the secondary container, measured from the bottom of the secondary container to the top of the highest primary container. For bulk containers, it is the height of the secondary container.

Weight Trigger – The weight under which the loaded container poses a low risk of injury thus no further analysis is needed. If the container exceeds its weight trigger, further analysis is required.

BWI WORLDWIDE

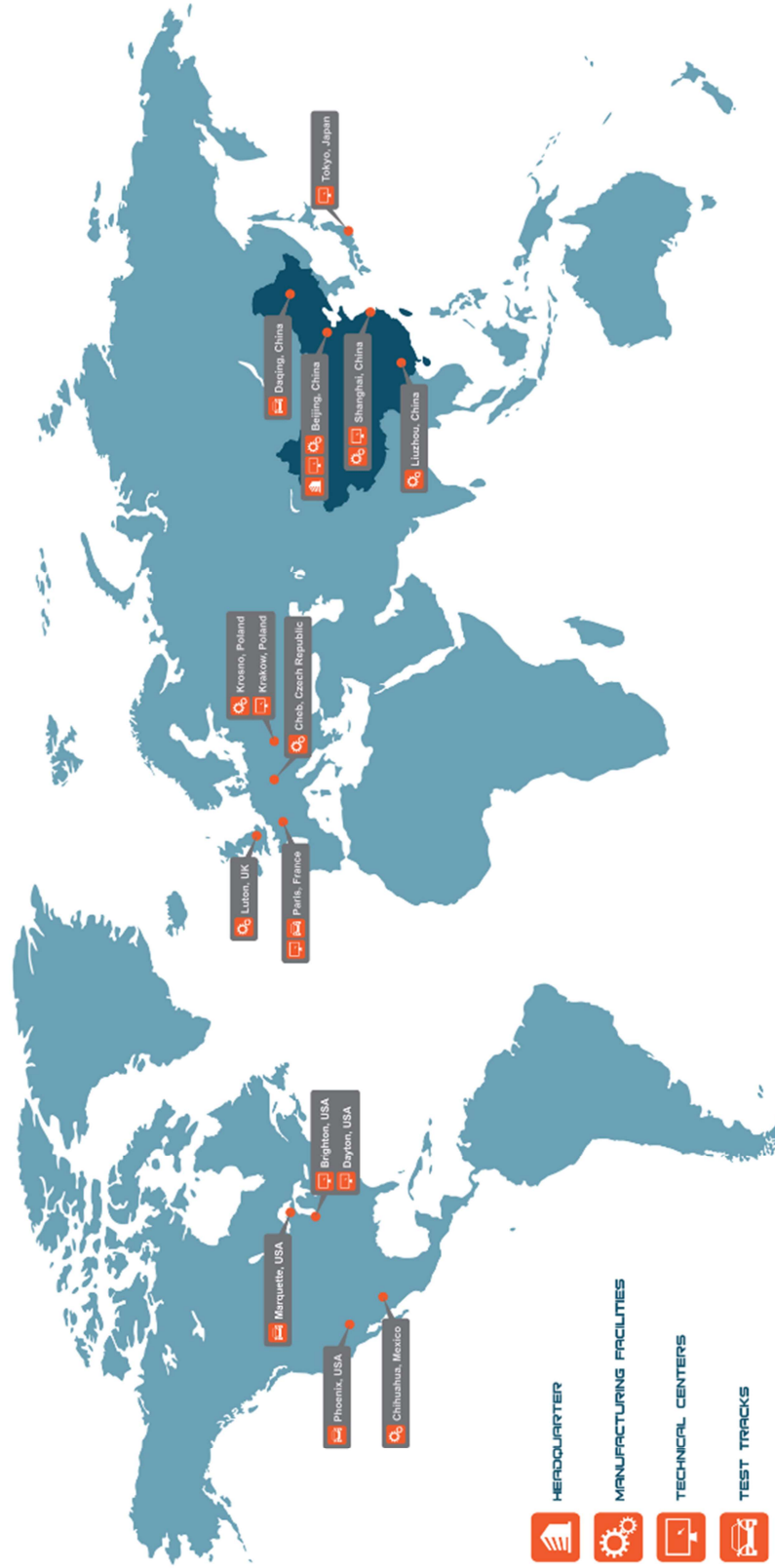

Revision Record:

Revision	Authority	Date	Originated By	Description
001	CN200009888,001	2018-05-16	A.Zachemska	Production Released